

6dB Directional Coupler 7-16 DIN Female, 698-2700MHz

RFDC-6DBC-DF

Low PIM

Low VSWR

Other Configurations Available

50 Ohms Impedance

RoHS Compliant

IP 67 Rated



GENERAL SPECIFICATIONS

Device Type	Directional Coupler
Interface	7-16 DIN Female
Color	Black
Dimensions.....	6.39" L x 3.25" W x 1.42" H
Bracket Included.....	Yes
Weight.....	1.59 lbs

ELECTRICAL SPECIFICATIONS

Operation Frequency Band.....	698-2700 MHz
3rd Intermodulation	≤ -155 dBc (relative to carrier)
3rd Intermodulation Test Method.....	Two +43 dBm carriers
Average Power	200 Watt
Impedance	50Ω
Coupling6dB
Coupling Tolerance	±0.8dB
Insertion Loss	≤ 1.7dB@698-2700 MHz
Isolation	≥ 26dB@698-2700 MHz
Peak Power	1 Kw
VSWR.....	≤ 1.20

MECHANICAL SPECIFICATIONS

Inner Contact Plating.....	Silver
Outer Plating.....	White Bronze (Tri-Metal)

ENVIRONMENTAL SPECIFICATIONS

Application	Indoor/Outdoor
Operating Temperature.....	-30°C ~ +75°C; -22°F ~ +167°F
Relative Humidity	Up to 100%
Regulatory Compliance / Certifications.....	RoHS / IP67

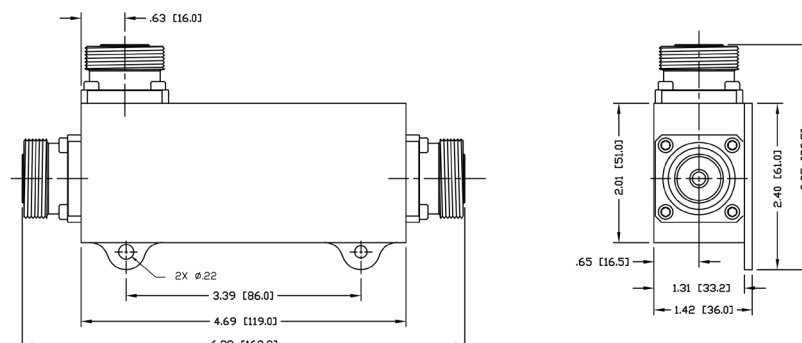

RF Industries

(NASDAQ: RFI)

7610 Miramar Road
San Diego, CA 92126

(800) 233-1728

(858) 549-6340

Fax: (858) 549-6345

rfi@rfindustries.com

www.rfindustries.com