

13dB Directional Coupler 4.3-10 Female, 698-2700MHz

RFDC-13DBC-43F

Low PIM

Low VSWR

Other Configurations Available

50 Ohms Impedance

RoHS Compliant

IP 67 Rated



GENERAL SPECIFICATIONS

Device Type	Directional Coupler
Interface	4.3-10 Female
Color	Black
Dimensions.....	6.43" L x 3.30" W x 1.42" H
Bracket Included.....	Yes
Weight.....	1.25 lbs

ELECTRICAL SPECIFICATIONS

Operation Frequency Band.....	698-2700 MHz
3rd Intermodulation	≤ -155 dBc (relative to carrier)
3rd Intermodulation Test Method.....	Two +43 dBm carriers
Average Power	300Watt
Impedance	50Ω
Coupling	13dB
Coupling Tolerance	± 1.0dB
Insertion Loss	≤ 0.5dB @ 698-2700 MHz
Isolation	≥ 33dB @ 698-2700 MHz
Peak Power	1.3Kw
VSWR.....	≤ 1.25

MECHANICAL SPECIFICATIONS

Inner Contact Plating.....	Silver
Outer Plating.....	White Bronze (Tri-Metal)

ENVIRONMENTAL SPECIFICATIONS

Application	Indoor/Outdoor
Operating Temperature.....	-30°C ~ +55°C; -22°F ~ +131°F
Relative Humidity	Up to 95%
Regulatory Compliance / Certifications.....	RoHS / IP67

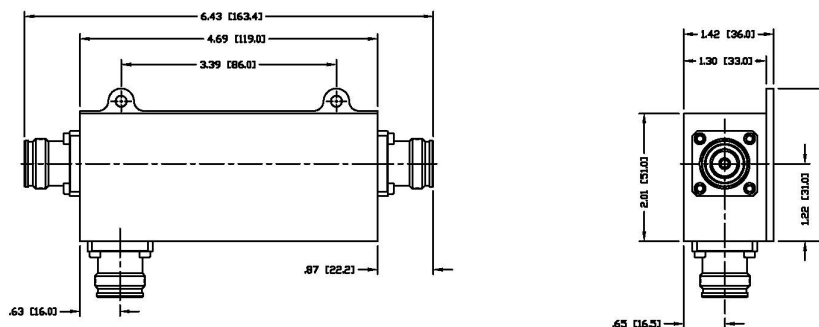

RF Industries

(NASDAQ: RFIIL)

7610 Miramar Road
San Diego, CA 92126

(800) 233-1728

(858) 549-6340

Fax: (858) 549-6345

rfi@rfindustries.com

www.rfindustries.com